

karma

User manual

VIP2 Series

(VIP2-T / VIP2-TR)



CE UK
CA

A Better Wheelchair, A Better Fit

GENERAL WARNING

- DO maintain your chair well, in particular check the tire pressure since this affects the efficiency of the brakes. To know the correct tire pressure, please see the walls of the tires.
- DO make sure both brakes are applied before getting in or out of the chair.
- DO make sure both brakes are applied when the chair is not being pushed or used.
- DO take care when climbing kerbs or turning on slopes.
- DO avoid steep or uneven surfaces that may cause the chair to tip over.
- DO avoid soft surfaces because the castors may become bogged down.
- DO travel smoothly in all conditions.
- DO look well ahead to anticipate hazards such as furniture, doors, potholes, etc.
- DO make sure that both feet are safely on the footrests and that clothing is safely tucked out of the way so that it cannot get caught in the wheels.
- DO take care when traveling up or down or across inclines.
- DO keep both hands on the push handles to control the chair, if you are the attendant.
- DO pay attention to keep the wheelchair balanced.
- DO check the frame and components regularly and refer to this user guide during and after the warranty period.
- DO tie-up the upholstery or replace which with a new one when it becomes loose.
- DO lubricate bearings regularly.
- DO equip with anti-tippers to avoid falling backwards.
- DO equip with a seat belt designed for disabled people.
- DO equip with "ankle supports" for disabled people.
- DO clean both hands after oiling the wheelchair.
- DO keep far away from flame.
- DO tighten the screws of headrest tubes (if applied).
- DO NOT overload the chair in any circumstance.
- DO NOT hang anything heavy on the back of the chair that could cause the

chair to become unstable, particularly when negotiating inclines.

- DO NOT allow more than one user at a time.
- DO NOT use with an unconscious patient.
- DO NOT use other transport to pull the wheelchair.
- DO NOT do "wheelies", as you may fall or tip over backwards and suffer a severe injury.
- DO NOT sit in a wheelchair within a moving vehicle unless it has affixed the labels of hook mark.
- DO NOT go too fast or turn too quickly.
- DO NOT stand on the footplates when getting in or out of the chair.
- DO NOT go down steps forward, whether solo or with an attendant.
- DO NOT attempt to lift the wheelchair by any removable (detachable) parts. Lifting by means of any removable (detachable) parts of the wheelchair may result in injury to the user and/or assistant or damage to the wheelchair.
- DO NOT use the wheelchair when the back is folded. This alters the center of gravity and may cause the wheelchair to tip backwards. The back should only be folded for storage or transport of the wheelchair.
- DO NOT hang anything on the back joint that could cause the backrest folding suddenly and may cause injury.

YOU AND YOUR KARMA SERVICE PROVIDER

- No tools are required for assembly. Your wheelchair should be assembled by your authorized KARMA dealer. Your authorized KARMA dealer is also your service provider. Unauthorized repairs, upgrades and add-ons will void your warranty. Anything wheelchair related that requires tools should be done by your authorized KARMA service provider. Your KARMA service provider has the necessary service/maintenance manual for your wheelchair.
- If you have any defective parts or lose any parts, please contact your dealer for repair and/or replacement. Please only use parts authorized by KARMA. Use of parts that are not authorized by KARMA will void your warranty.
- Part numbers are listed on our bill of materials (explosion drawings), which we give to our authorized dealers and service providers. Customers should

order parts through their dealer as well as all repairs and scheduled maintenance.

- Customers should go to their dealer for all service needs to guarantee their warranty is not void. Always go to an authorized service provider. Unauthorized repairs will void your warranty. Procedures other than those described in this manual must be performed by a qualified technician. They also have the service manual with a complete list of maintenance required to keep your KARMA wheelchair in top performance. Please check the warranty section of this manual to find out what KARMA guarantees and what maintenance and parts that are not covered by our warranty.
- KARMA does not have an official list of service providers at this time. Please contact your dealer for service. If you cannot contact your dealer, please contact another authorized KARMA dealer for service. If all else fails, contact KARMA directly via our website or give us a call and we can refer you to your new service provider.

CE MARKING

- This wheelchair complies with the requirements of the Medical Devices Regulation (EU) 2017/745.



CAUTION:

- When prescribing wheelchairs for use by full or partial amputees (above or below knee, single or double) or other conditions that affects the user's natural center of gravity and might cause the wheelchair to tip or the person on the wheelchair to fall off, we suggest contacting your therapist or dealer as well as attaching anti-tippers, pelvic belt, or other additional safety accessories.
- Anti-tippers **MUST** be equipped all the times

TABLE OF CONTENTS

1. PREFACE.....	1
2. SAFETY	2
2.1 Before Using	2
2.2 While Moving.....	2
2.3 General	4
2.4 Upholstery.....	4
2.5 Anti-Tippers	5
2.6 Maximum User Weight Limit.....	5
2.7 Avoid General Misuse.....	5
2.8 Labeling	6
3. INTENDED USE & PARTS	7
3.1 Intended Use	7
3.2 VIP 2 Parts Description	8
4. OPERATION	10
4.1 Preparing For Use.....	10
4.2 Recline and Tilt operation	13
4.3 Headrest Adjustment.....	14
4.4 Detachable Armrest Adjustment	16
4.5 Footplate Height Adjustment	17
4.6 Footrest.....	18
4.7 Elevating and Swing-Away Footrest	19
4.8 Backrest Angle Adjustment (Tilt version only)	20
4.9 Pelvic belt.....	20
4.10 Manual Parking Brake.....	22
4.11 Anti-Tippers	23
4.12 Rear Wheel Disassembly	23
4.13 Rear Wheel Assembly	24
4.14 J-Hook Handle Rotation Test	25
4.15 Transferring In.....	25
4.16 Transferring Out.....	26
4.17 Going Up or Down Steps/Stairs.....	27
4.18 General Use	27
4.19 Storage	29
4.20 Transportation	29
5. INSPECTION AND MAINTENANCE	32
5.1 Daily Check	32
5.2 Regular Maintenance Record	32

6. ACCESSORIES.....	35
7. TROUBLESHOOTING	36
8. SPECIFICATIONS	37
9. CLEANING & RECYCLING.....	39
9.1 Cleaning.....	39
9.2 Recycling	39
10. WARRANTY	40
10.1 Serial Number.....	40
10.2 Warranty Policy	40

1. PREFACE



1.1 Please read this owner's manual carefully before using the wheelchair.

Any improper use of the wheelchair may result in harm or injury.

1.2 This owner's manual includes operation, unfolding/ folding instructions and how to prevent possible accidents for the aspects of the wheelchair.

1.3 This owner's manual is written for KARMA wheelchair: VIP2 Series.

1.4 The symbols used in this manual are explained below. Pay special attention to the parts marked with these symbols.

 WARNING:	Improper use could lead the user to severe injury or death.
 CAUTION:	Improper use could lead the user to severe injury and/or damage to your wheelchair.
 SUGGESTION	Follow these instructions to keep the wheelchair in good condition.

1.5 This manual includes the repair and maintenance chart as well as the warranty.

1.6 If someone else uses the wheelchair, make sure that you give him or her this owner's manual for his or her reference.

1.7 As designs change, some illustrations and pictures in this manual may not correspond to the wheelchair that you purchased. We reserve the right to make design modifications without further notice.

2. SAFETY

2.1 Before Using

The user and attendant must be familiar with the operation of the wheelchair before using. Pedestrian traffic rules apply to the wheelchair. Please be safe.

2.2 While Moving

Please always keep these following safety guidelines in mind.

2.2.1 Doorways

The safest way to operate the wheelchair is on level floors that are free of obstacles. If possible, always use a ramp to enter or exit a facility. Keeping your hands on the push rims will allow you to maintain the maximum balance. DON'T try to force yourself over an obstacle and use the sides of a doorway to pull yourself through a passageway.

2.2.2 Leaning and Standing

DO NOT lean over the side or stand on the wheelchair since such an action may cause you to lose balance and fall. (See Figures 2.1 and 2.2)

2.2.3 Negotiating Inclines

2.2.3.1. Never turn on a hill due to the danger of tipping over.

2.2.3.2. When an attendant is pushing the wheelchair straight up a slope, if the user needs to go down midway on the slope, walk backwards until the user is on level ground. (See Figures 2.3 and 2.4)



Figure 2.1



Figure 2.2



Figure 2.3



Figure 2.4

2.2.3.3. Do not drive on 7 degrees of incline to avoid danger. When negotiating inclines, don't propel up to 3 degrees of inclines diagonally.

2.2.3.4. Avoid stopping on an incline, it can potentially cause you to lose control of the wheelchair.

2.2.3.5 Do not use the brakes to slow down or stop the wheelchair, this could cause it to stop suddenly and make the user lose control or fall out of the wheelchair.

2.2.3.6 Whenever possible, utilize help from an assistant/attendant while negotiating inclines.



CAUTION:

- Although the product has met ISO 7176-1 requirements, we still recommend you not to drive on any slope (in any direction) greater than 7 degrees.

2.2.4 Kerbs

2.2.4.1. Whenever possible, get help from an assistant/attendant. If you have assistance, make sure that your chair is equipped with push handle.

2.2.4.2. DO avoid huge impacts when descending a kerb. A huge impact could probably damage the wheelchair.

2.2.4.3. Never try to scale or descend a kerb that exceeds a normal height.

2.2.4.4. Always be careful and never move up or down a kerb in reverse without an attendant.



WARNING:

- Any improper use of the wheelchair could cause severe injury or death.
- For increasing your safety, please make sure that you have realized those guidelines as mentioned previously.
- ALWAYS follow The Use of Invalid Carriages on Highways Regulations outdoors and the guidelines written in this owner's manual.

2.2.5 Streets

2.2.5.1. Always cross streets with great caution.

Reflective tape on the wheelchair and/or your clothing will make you more visible to drivers.

2.2.5.2. Please comply with traffic safety code.

2.2.5.3. Avoid potholes and rough terrain that might cause the casters to get stuck.(See Figures 2.5)



Figure 2.5

2.2.6 Stairs

2.2.6.1. Always use two or more assistants. Tilt the wheelchair to its point of equilibrium. One assistant (at the back) holds the wheelchair up against the first step, gripping the handles firmly to lift. The second assistant, holding firmly a fixed part of the front frame, lifts the wheelchair above the stairs and holds it while the first attendant places one foot on the following step and repeat the operation. (See Figures 2.6~2.7)

2.2.6.2. Never go down steps forwards.

2.2.6.3. Never use an escalator for transport; use an elevator.



Figure 2.6



Figure 2.7

2.3 General

2.3.1 The expected service life of the product is **five years**, presuming that the product is used daily in accordance with the safety operation instructions, inspection and maintenance instructions, and intended use, which described in this manual.

2.3.2 Always make sure BOTH brakes are applied before getting in or out of the wheelchair.

2.3.3 Never stand on the footplates when getting in or out of the wheelchair

2.3.4 Never carry more than one passenger. KARMA wheelchairs are limited to one user.

2.3.5 Use caution to assure your clothing doesn't get tangled with the wheels.

2.4 Upholstery

2.4.1 When cleaning the upholstery, use warm water and a mild soap.

2.4.2 Upholstery cleaner/foam can also be used, but avoid other cleaning solvents.

2.4.3 Do stay far away from any flame because it might injure the user and

damage the wheelchair

2.5 Anti-Tippers

Always use them to avoid personal injury. The distance between the end of each anti-tipper and the rear wheel is at least 5 cm; the distance to the ground is no more than 5 cm.

2.6 Maximum User Weight Limit

2.6.1 The maximum user weight limit for VIP 2 Series is 115 kg. For detail information, refer to Section 8. SPECIFICATIONS.

2.6.2 Please note that loading exceeding maximum capacity can damage your wheelchair and cause malfunctions, which leads to a safety hazard. The warranty does not cover damage caused by improper operation of the wheelchair.

2.7 Avoid General Misuse

Please note that our "Owner's Manual" contains a number of cautions -- any vehicle can cause injury if misused -- use within our guidelines and with reasonable care and your safety will be increased. Your wheelchair will give years of safe use if used sensibly and carefully. Be aware that careless use endangers your own safety as well as that of others. ALWAYS follow the Highway Code when outdoors and the guidelines written in this manual.

2.8 Labeling

Please carefully read all the labeling on the wheelchair before driving it. Do not remove them. Protect them for future reference.

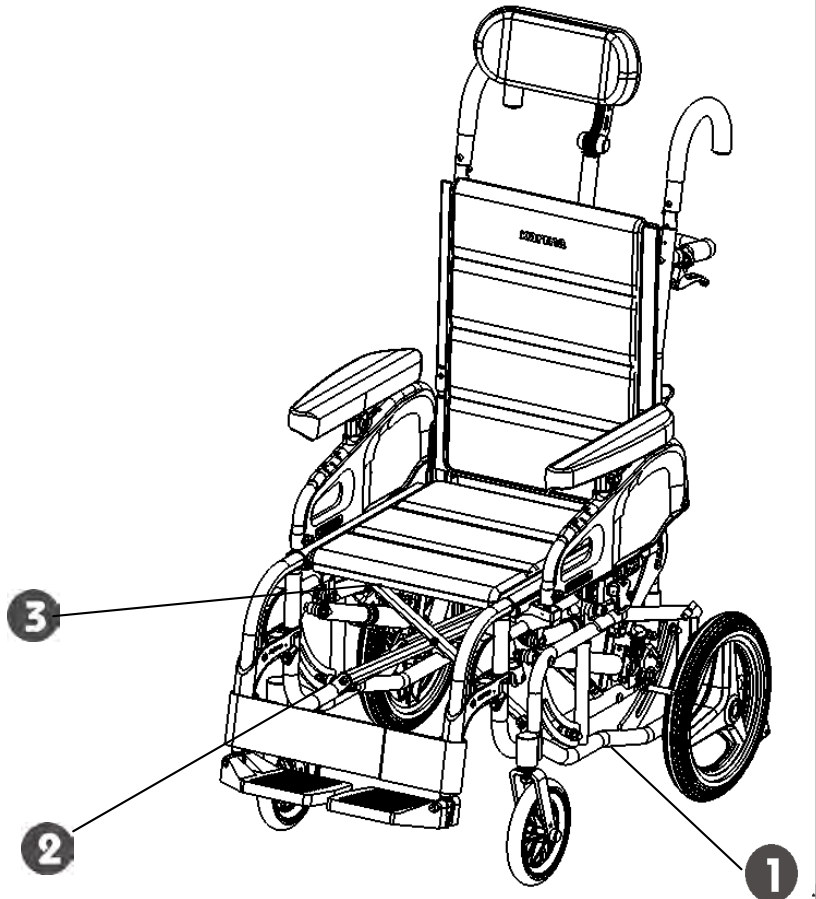

1

EC	REP	KARMA MOBILITY, S. L. C/ PERIODISTA FRANCISCO CARANTONA DUBERT, 23 Bajó 33209 GUÓN - ASTURIAS (SPAIN)	CE
UK	REP	KARMA MOBILITY LTD. UNIT 6 TARGET PARK, SHAWBANK ROAD, REDDITCH, B98 8YN ENGLAND UNITED KINGDOM	
		KARMA MEDICAL PRODUCTS CO., LTD. NO. 2363, SEC. 2, UNIVERSITY RD., MIN-HSIUNG SHIANG, CHIA-YI HSIEN, TAIWAN R.O.C.	UK CA MD
		WARNING! USE ONLY ON STABLE SURFACES MAXIMUM USER WEIGHT 115kg (255 lbs)	

2



karma SERIAL NO. M12-1234

3

Model:	
Order No.:	
Delivery Date:	
Sewing No.: 1 <input type="checkbox"/> 2 <input type="checkbox"/> 3 <input type="checkbox"/> 4 <input type="checkbox"/> 5 <input type="checkbox"/> 6 <input type="checkbox"/>	
Seat Width	Seat Depth
<input type="checkbox"/> 13	<input type="checkbox"/> 13
<input type="checkbox"/> 14	<input type="checkbox"/> 14
<input type="checkbox"/> 15	<input type="checkbox"/> 15
<input type="checkbox"/> 16	<input type="checkbox"/> 16
<input type="checkbox"/> 17 <input type="checkbox"/> 0	<input type="checkbox"/> 17 <input type="checkbox"/> 0
<input type="checkbox"/> 18 <input type="checkbox"/> 5	<input type="checkbox"/> 18 <input type="checkbox"/> 5
<input type="checkbox"/> 19	<input type="checkbox"/> 19
<input type="checkbox"/> 20	<input type="checkbox"/> 20
<input type="checkbox"/> 21	<input type="checkbox"/> 21
<input type="checkbox"/> 22	<input type="checkbox"/> _____
<input type="checkbox"/> _____	<input type="checkbox"/> _____
karma	Unit: inch

3. INTENDED USE & PARTS

3.1 Intended Use

- 3.1.1 The VIP 2 Series is a self-propelled or transit wheelchair. That is, it can either be propelled by the user (self-propelled) or by an attendant (transit).
- 3.1.2 It is designed to be used indoors, and with certain restrictions outdoor.
- 3.1.3 It is suitable for a single user up to 115 kg in weight. Hand brakes are provided for both rear wheels.
- 3.1.4 It is a highly adjustable wheelchair, and the detachable parts are easy to operate.
- 3.1.5 Rear wheels with 14" /20" solid tires and ergonomic handrims are provided with 20" tires. It also has an extremely durable aluminum alloy frame with tough accessories and does not deteriorate when exposed to extreme temperature.(neither the user nor the attendant need to touch any metal part in normal use)
- 3.1.6 When prescribing wheelchairs for use by full or partial amputees. (above or below knee, single or double) or other conditions that affects the user's natural center of gravity, we suggest contacting your therapist or dealer as well as attaching anti-tippers.
- 3.1.7 Please contact your dealer for the optional accessories of the VIP 2 series which are planned to be launched shortly.

3.2 VIP 2 Parts Description



- | | |
|-------------------------|--------------------------------------|
| 1. J-Hook Handle | 9. Caster |
| 2. Push Handle | 10. Height-adjustable Armrest |
| 3. Attendant Brake | 11. Seat Upholstery |
| 4. Backrest Upholstery | 12. Swing-Away & Detachable Footrest |
| 5. Side Panel | 13. Cross Bar |
| 6. Manual Parking Brake | 14. Heel Loop |
| 7. Rear Wheel | 15. Footplate |
| 8. Outside Frame | |



1. Headrest Pad

2. Headrest Assembly

3. Recline Release Handle

4. Lateral Supporter Joint

5. Tilt Release Handle

6. Backrest tube joint

7. Anti-tippers



CAUTION:

- Standard equipment are subject to change without notice.

4. OPERATION

4.1 Preparing For Use

4.1.1 Unpacking

4.1.1.1 If any part proves defective or missing, please notify your dealer immediately.

4.1.1.2 Please consult this owner's manual for complete instructions on the installation and operation of your VIP 2.

4.1.2 Assembly of Swing-Away & Detachable Footrests

Please follow the below instructions for the assembly of Swing-Away & Detachable Footrests.

4.1.2.1 Footrests are packaged in a carton. (See Figure 4.1).

4.1.2.2 The items included are as show in the list below. (See Table 4.1 and Figure 4.2)

4.1.2.3 Insert the footplate into the footrest. (See Figure 4.3)

4.1.2.4 Adjust the footplate to the appropriate length, and insert the bolt and the nut. (See Figure 4.4 and 4.5)

4.1.2.5 Use the #4 Allen Key and wrench provided by KARMA to tighten the bolt and the nut. (See Figure 4.6)



Figure4. 1



Figure4. 2

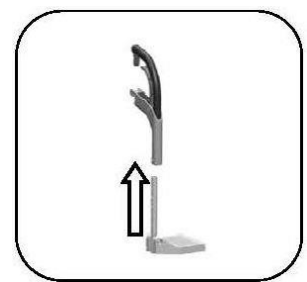

Figure4. 3



Figure4. 4



Figure4. 5



Figure4. 6

Table 4.1 Swing-Away & Detachable Footrest Assembly Part List		
No	Part	Quantity
1	Swing-Away & Detachable Footrest	2
2	Tube-in-Centre Footplate	2
3	M6 Bolt	2
4	M6 Nut	2
5	Calf Strap	2

4.1.3 Unfolding

While unfolding the VIP 2, follow these instructions as listed below:

4.1.3.1 Stand at the side of the wheelchair as you prefer, hold the armrests and pull outwards. (See Figure 4.7)

4.1.3.2 Pull the push handles upward and make joint be clamped (See Figure 4.8)

4.1.3.3 Put your hands on side panels and pull them outward (See Figure 4.9)

4.1.3.4 Put your two hands on the seat pan and push down until the seat is fully lowered, be careful not to get your fingers caught. Make sure the frame is firmly seated in its holder (See Figure 4.10)

4.1.3.5 Make lateral support bar be fixed by pushing downward. (See Figure 4.11)

4.1.3.6 Install the footrests. (See Figure 4.12)

4.1.3.7 Flip the footplates down. (See Figure 4.13)

4.1.3.8 Place the back and seat cushion on the wheelchair.

4.1.3.9 Ready to use!



Figure4. 7



Figure4. 8



Figure4. 9



Figure4. 10



Figure4. 11



Figure4. 12



Figure4. 13



CAUTION:

- While completing step 4.1.3.4, never put your fingers around the sides or under the wheelchair as they can be trapped between the seat and the frame. (See the figure at the right.)
- The calf straps should be adjusted to the length appropriate for the user's condition.



4.1.4 Folding

While folding the wheelchair, follow these instructions as listed below:

4.1.4.1 Flip up the footplates. (See Figure 4.14)

4.1.4.2 Pull up the seat by holding the front and the back of the seat.

(See Figure 4.15)

4.1.4.3 Make lateral support bar be released by pulling upward.

(See Figure 4.16)

4.1.4.4 Release the backrest tube joint and fold them downward.

(See Figure 4.17)

4.1.4.5 Folding is now completed.



Figure4. 14



Figure4. 15



Figure4. 16



Figure4. 17



CAUTION:

- Be careful not to get your fingers caught when folding the wheelchair.

4.2 Recline and Tilt operation

Please follow below instructions to recline and tilt operation

4.2.1 Apply the brakes.

4.2.2 Operate the release handles to achieve recline/tilt function

(See Figure 4.18)

4.2.3 The Label on the recline releasing handle (orange color) is as Figure 4.19

4.2.4 The Label on the tilt releasing handle (blue color) is as Figure 4.20



Figure4. 18



R

Figure4. 19



T

Figure4. 20

4.2.5 While releasing recline handle first and hold, then pull lateral support bar backward and downward, recline operation can be achieved. (See Figure 4.21)



CAUTION:

- Recline angle adjusting range is 0 ~ 30 degrees.

4.2.6 While releasing tilt handle first and hold, then pull lateral support bar backward and downward, tilt operation can be achieved.

(See Figure 4.22)



Figure4. 21



Figure4. 22



CAUTION:

- Tilting angle adjusting range is 0 ~ 35 degrees.

4.2.7 Release the brakes.

4.3 Headrest Adjustment

There are 2 headrest types for users:

4.3.1. Adjustable curved headrest is as Figure 4.23

4.3.2. Curved headrest is as Figure 4.24



Figure4. 23



Figure4. 24

Please follow below instruction to adjust headrest

4.3.3 Use #3 Allen key to loosen the hex socket head screw on fixation ring, adjust the fixation height of rod and lateral direction angle.

(See Figure 4.25)

4.3.4 Assemble the headrest assembly to clamp ring by pin-hole positioning, tighten by using the lever of ratchet bolt (See Figure 4.26)

4.3.5 Remove rubber cap and use #5 Allen key to loosen screws, can adjust headrest linkages. Loosen the screw that the nearest headrest pad to adjust the headrest pad fitting. (See Figure 4.27、Figure 4.28)

4.3.6 Use #5 Allen key to loosen hex socket head screw near the upper ball head, adjust the fitting of the headrest pad. The adjustable curved headrest can change left/right pad support angle. (See Figure 4.29)

4.3.7 Unzip the cover upholstery, use #5 Allen key to loosen hex socket screw of hinge near the left/right pad, can adjust the pad rotation angle.

(See Figure 4.30, 4.31)



Figure4. 25



Figure4. 26



Figure4. 27



Figure4. 28



Figure4. 29



Figure4. 30

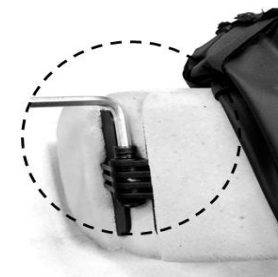

Figure4. 31

4.4 Detachable Armrest Adjustment

4.4.1 Height-adjustable armrest

4.4.1.1 Use #5 Allen key and #13 wrench to adjust height (4 positions) (See Figure 4.32 and 4.33)

4.4.1.2 Remove the screw and adjust the height as desired, then re-tighten screw.



Figure4. 32



Figure4. 33



Figure4. 34

4.4.2 Detachable armrest bracket adjustment

4.4.2.1 Use #4 Allen Key and #10 wrench to adjust the tightness between the bracket and armrest tube (See Figure 4.34)

4.4.3 Detachable Armrest

4.4.3.1 Remove armrest

4.4.3.1.1 Pull the lock lever upward (See Figure 4.35)

4.4.3.1.2 Holding the armrest and side panel, pull them upward to remove (See Figure 4.36)

4.4.3.2 Install Armrest

4.4.3.2.1. Holding the armrest and side panel, push them downward to install (See Figure 4.37)

4.4.3.2.2 Push the lock lever downward (See Figure 4.38)



Figure4. 35



Figure4. 36



Figure4. 37



Figure4. 38



CAUTION:

- The adjustment is in increments of 2 cm (4 positions), and the range of adjustment is 6 cm.
- Do not sit on the armrest in any circumstances.

4.4.4 Hemi Armrest Angle Adjustment

4.4.4.1 Pull down the dowel pin. (See Figure 4.39)

4.4.4.2 There are four angles can be adjusted. (See Figure 4.40)

4.4.4.3 Turning the armrest, and adjust the position as desired. (See Figure 4.41)

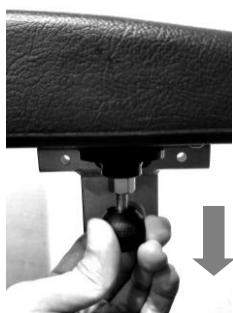

Figure4. 39

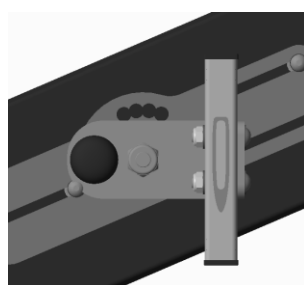

Figure4. 40

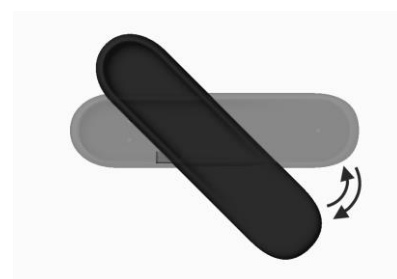

Figure4. 41

4.5 Footplate Height Adjustment

To adjust the footplate height, follow the instruction as listed below:

4.5.1 Use #4 Allen key and #10 wrench to loosen the bolts at the bottom part of the footrest. (See Figure 4.42)

4.5.2 Adjust the height till the user feel comfortable or the user's thighs are parallel to the ground. Retighten the bolts.



Figure4. 42



Figure4. 43



Figure4. 44



Figure4. 45



CAUTION:

- The adjustment is in increments of 2.5 cm (5 positions), and the range of adjustment is 10 cm.
- Make sure that the footplate height is adjusted properly according to the user's calf length to reduce pressure on the body. (See Figure 4.43 and 4.44)
- The distance between the footplates to the floor must be more than 3 cm from the floor. (See Figure 4.45)

4.6 Footrest

Footrests can be swung away and be detached, which makes transferring out easier. Please follow below instructions to swing away and detach them.

4.6.1 Unfasten the calf straps. (See Figure 4.46)

4.6.2 Flip up the footplates. (See Figure 4.47)

4.6.3 Hold the release lever and swing the footrest to the side. Depending on the environment the user is in, you can swing it inward or outward. (See Figure 4.48)

4.6.4 When the footrest is swung to the side, it can be detached by lifting it up. (See Figure 4.49)



Figure4. 46



Figure4. 47



Figure4. 48



Figure4. 49

4.7 Elevating and Swing-Away Footrest

4.7.1 Flip up the footplates. (See Figure 4.50)

4.7.2 Hold the release lever and swing the footrest to the side. Depending on the environment the user stay, you can swing it outward. (See Figure 4.51)



Figure4. 50



Figure4. 51

4.7.3 Lower Down : Press down the orange lever and hold the linkage to prevent from sudden falling (See Figure 4-52) °

4.7.4 Calf Pad Adjustment : Left/Right, Up/down adjustment based on user' s condition

4.7.4.1 Front/Back direction adjustment

4.7.4.1.1 Using #6 Allen Key to loosen screw to achieve (See Figure 4-53, See Figure 4-54)

4.7.4.2 Left/Right direction adjustment

4.7.4.2.1 Using #2.5 Allen Key to loosen screw to achieve (See Figure 4-55)

4.7.4.3 Up/Down Adjustment

4.7.4.3.1 Using #6 and #2.5 Allen Key to loosen screws to achieve (See Figure 4-56, 4-57) °



Figure4. 52



Figure4. 53

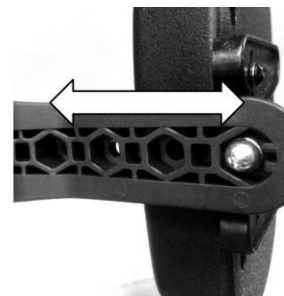

Figure4. 54

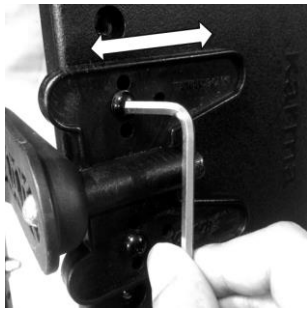

Figure4. 55

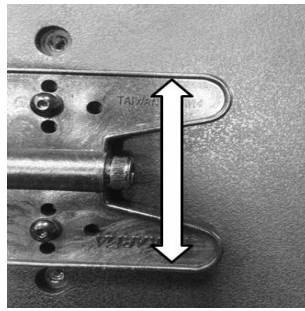

Figure4. 56



Figure4. 57

4.8 Backrest Angle Adjustment (Tilt version only)

To adjust the backrest angle, follow the instruction as listed below:

- 4.8.1 Use #4 Allen key and #10 wrench to loosen bolt/nut on backrest bracket. (See Figure 4.58)
- 4.8.2 Adjust the position as desired. (See Figure 4.59)
- 4.8.3 Retighten the bolts and nuts firmly.



Figure4. 58



Figure4. 59



CAUTION:

- The adjustment is in increments of 5° (4 positions), and the range of adjustment is 15° (from 0° to 15°)

4.9 Pelvic belt

Please follow the instructions below to use the pelvic belt for your safety.

4.9.1 How to Operate It

- 4.9.1.1 When you sit on the wheelchair, fasten the pelvic belt. (See Figure 4.60)
- 4.9.1.2 Adjust the belt and make it fit your body for comfort and safety.
- 4.9.1.3 When you don't use it, please fasten the belt to



avoid the belt dropping into the rear wheels during motion.



SUGGESTION:

- Please kindly be advised that the pelvic belt should be fitted tightly around the user's pelvis and be tightened until you can just get one finger through between the pelvic belt and the user. Kindly check the pelvic belt position is fitted to the place as we recommend. If it is not able to be this way, please consult your supplier.

4.9.2 Pelvic belt Adjustment

4.9.2.1 Make sure that the total length of the pelvic belt is sufficient.

4.9.2.2 Adjust the length of the pelvic belt through the buckle of both ends.

(Figure 4.61)

4.9.2.3 Pull the two parts of belt tight. (Figure 4.62)

4.9.2.4 Push the buckle of both ends to the plastic clip so that the pelvic belt will not slip out of the position.



Figure4. 60



Figure4. 61

4.9.3 Maintenance

The pelvic belt is made from 100% polyester fibers and the clasp is made from plastic. It does not require any maintenance but should be inspected every month to ensure that the edges are not frayed and weekly to make sure that it correctly fits the user.



CAUTION:

- **Maintenance:** There is no specific maintenance for the pelvic belt; however, please check if the edge of the pelvic belt is worn or torn before you use it. Meanwhile, please adjust the pelvic belt properly to fit the user. If the pelvic belt is damaged, please replace a new one immediately.

4.10 Manual Parking Brake

This wheelchair is equipped with two manual parking brakes.

4.10.1 They are applied directly against the tires. Push the handle of the manual brake forward to engage and pull the handle of to release.

4.10.2 Braking could be less efficient due to:

4.10.2.1 Worn tire tread.

4.10.2.2 Wet tires

4.10.2.3 Improper wheel locks adjustment.

4.10.3 The manual parking brakes are not designed to be used for a moving wheelchair.

4.10.4 Always use the hand rims or attendant parking brake for braking when you are in a moving wheelchair. Make sure that the interval between the tires and the brakes complies with the given specifications. (See Figure 4.63)

4.10.5 To adjust the interval between the tires and the brakes, first loosen the bolts and set the appropriate gap. Then re-tighten the bolts. (See Figure 4.64)



Figure4. 62



Figure4. 63



CAUTION:

- After each adjustment of the rear wheels, check the manual brake gap and re-adjust if necessary.

4.11 Anti-Tippers

The main purpose of anti-tippers is to prevent the user from tipping over backward.

4.11.1 To insert the anti-tipper firmly and make sure the retainer button is fitted to hole. Try to move anti-tipper forward and backward without pressing release button, if no moving, anti-tipper is fixed firmly (See Figure 4.65)



Figure4. 64



CAUTION:

- Make sure the anti-tipper always is assembled firmly when user is on chair. If the anti-tippers are not fitted, or have been fitted incorrectly, there is a risk of tipping over and of injury.

4.12 Rear Wheel Disassembly

Quick release rear wheels are optional. If your wheelchair is equipped with quick release rear wheels, please follow these instructions as listed below.

4.12.1 Ensure that the brake is in the unlocked position first.

4.12.2 Support the weight of the chair with one hand by holding the push handle.

4.12.3 Press the hub cover and pull out the rear wheel.

4.12.4 Remove the rear wheel. (See Figure 4.66)

4.13 Rear Wheel Assembly

4.13.1 First ensure that the brake is in the OFF position.

4.13.2 Take up the wheel with axle and press the hub cover in the center of the axle, as above.

4.13.3 This retracts the ball bearings that will allow you to push the axle into the wheel bracket that is located on the lower rear frame of the wheelchair.

4.13.4 When you remove your thumb from the button on the axle, the ball bearings should be visible protruding from the axle at the back of the wheel bracket. This will secure the wheel safely in the frame.

(See Figure 4.67)



Figure4. 65

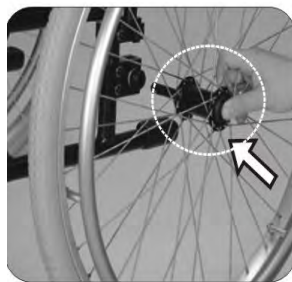

Figure4. 66



CAUTION:

- You must make sure that the axle is fully located in the wheelchair bracket and that the ball bearings are fully open and have positively attached the wheel in the frame.
- The rear wheel can be mounted at different positions on the frame to alter the seat height and overall stability of the chair. Changing the wheel position should be carried out by your approved repairer or therapist.
- Do keep the axle clean and lubricated with light oil or maintenance spray.
- If pneumatic tires are fitted, please maintain them at the correct tire pressure.
- When the wheelchair is occupied, DO NOT try to remove the rear wheel even when anti-tippers are equipped.

4.14 J-Hook Handle Rotation Test

4.14.1 Pull up the J-hook and rotate the left and the right side. (Figure 4-68)

4.14.2 Make sure the right hook can be swung away ONLY to the right. The left one can be swung away only to the left. If the hooks can be rotating inward, then it will create collision.



Figure4. 67



CAUTION:

- After the installation is completed, double check if the leftward and rightward swinging movement of the J-Hook Handles are normal.
- Check every part and structure to see if they are operating normally.
- The swinging movement is allowed within the range of 180 degree and is set to manipulate lateral.

4.15 Transferring In

4.15.1 Engage both manual parking brakes.

4.15.2 Turn the footplates up and swing them to the side.

4.15.3 Lower the user into the seat, allowing them to use the armrests for support.

4.15.4 Turn the footplates back down, so that the user can place his feet on them.



CAUTION:

- Always ensure that the front casters are in line with the rear wheels and pointing forwards and that the back of the chair is secure either against a wall or firmly held by an attendant.

4.16 Transferring Out

4.16.1 Sideways transfer.

This approach is appropriate for users with sufficient torso strength.

4.16.1.1 Flip back your armrest, and make sure that the chair is near your final destination.

4.16.1.2 Prop up your body and move sideward slowly, using transfer board. Be careful not to hit the brake or other components of wheelchair.

4.16.2 Front transfer

This approach is appropriate for users who are more or less able to stand up and have strong upper body.

4.16.2.1 Make sure that the place where you're moving to is as close to you as possible.

4.16.2.2 Move the wheelchair backwards so that the casters are pointing forwards and are in line with the rear wheels.

4.16.2.3 Ensure that, where possible, the rear of the chair is against a wall or, if not, it must be firmly held by an attendant.

4.16.2.4 Engage both hand brakes.

4.16.2.5 Turn the footplates up and swing them to the side.

4.16.2.6 Slide forwards on the seat. Place one foot firmly on the ground with the knee at a right angle and the other foot slightly apart and further back.

4.16.2.7 Place your hands on the front of the armrests and moving your weight forward, bring your head and shoulders up over your knees as you push yourself up.



CAUTION:

- Never stand on the footplates when getting into (or out of) the chair. (See Figure 4.69)
- When getting in and out of the wheelchair please use the manual parking brakes. The manual parking brake is the lever at the side of the wheelchair.
- Make sure that the manual parking brakes are applied to prevent the chair from sliding away. Also see that the footplates are flipped up for ease of entering or exiting. (See Figure 4.70)

- Please ensure that neither the tread on your tires nor the brake block has become too worn. If pneumatic tires are fitted, please maintain at the recommended tire pressure for the same reason.
- Please ensure that occupant's fingers do not get caught in the brake.



Figure4. 68



Figure4. 69

4.17 Going Up or Down Steps/Stairs

- 4.17.1 Please note: avoid flights of steps particularly if no extra help is available. Use ramps or lifts wherever possible.
- 4.17.2 Two attendants are necessary, each capable of carrying at least half of the combined weight of the person and the wheelchair.
- 4.17.3 Each helper should bend at the knees and grip the main frame: with the front attendant's hands just under the front of the seat, with the back attendant's hands holding the frame just under the push handles.



CAUTION:

- Never hold on to movable or detachable parts.
- ALL LIFTING SHOULD BE DONE WITH A STRAIGHT BACK.
- Straighten legs to lift the wheelchair. Carefully carry it up or down steps; be aware of how you place your feet -- do not cross them and trip yourself up.

4.18 General Use

In conditions of normal use in attendant pushing or self-propelling, please follow the instructions below.

- 4.18.1 Ensure that the brakes are always locked when the chair is not being pushed. (See Figure 4.71)
- 4.18.2 Always make sure that both feet are safely on the footplates and that clothing is safely tucked out of the way and cannot get caught in the wheels. (See Figure 4.72)
- 4.18.3 Always use both hands on the push handles to control the chair. (See

Figure 4.73)

4.18.4 Always avoid steep or uneven surfaces because the chair may tip over.

(See Figure 4.74)

4.18.5 Always avoid soft surfaces because the casters may get bogged down.

(See Figure 4.75)

4.18.6 Always be careful not to go too fast or turn too quickly and try to maintain a smooth and steady ride.

4.18.7 Before crossing the road, please stop completely and look both ways.

4.18.8 Cross tracks or ruts at right angles to avoid your casters getting stuck.

4.18.9 Do not drive at full speed over the railroad tracks.

4.18.10 Please keep your hands and arms inside the wheelchair when going through doorways.

4.18.11 Note to the attendant- PLEASE keeps in contact with the person in the chair. If you stop to look in shop windows or talk to people, remember to turn the chair so that the person in the chair does not have to turn.



WARNING:

- NEVER lock the brakes too quickly as this may tip the user out of the wheelchair.



Figure4. 70



Figure4. 71



Figure4. 72



Figure4. 73



Figure4. 74



WARNING:

- Don't put anything on the wheelchair while it is in storage. Storing goods on a folded wheelchair will cause damage and is not covered under warranty. (See the figure at the right.)



4.19 Storage

Make sure that the wheelchair is fully folded when it is in storage.



SUGGESTION:

- Please store the wheelchair in a location where it is out of direct sunlight, rain and dew. For more details, consult your KARMA dealer.

4.20 Transportation

VIP 2 has been crash tested to ISO7176-19 (TRL Project Reference: PTD 248 (D248I01)) and is suitable to be used as a seat in a vehicle that has been adapted for this purpose. The wheelchair must be securely restrained as described in this manual. The VIP 2 was tested with a four point webbing system. For further information on the use of wheelchair restraints please refer to the manufacturer's user guide. KARMA always recommends that the user be transferred into the seat of the vehicle with a safety belt or harness while in a transport.



WARNING:

- Please transfer to a seat in the vehicle when possible.

4.20.1 Before use

4.20.1.1 Please detach all easily removable accessories from the wheelchair and store them in a safe place where they cannot move around and become a safety hazard.

4.20.1.2 A four point tie-down system should tightly fasten to the lower wheelchair frame marked with a yellow sticker as pictured at the right.



4.20.1.3 An occupant restraint system using both a pelvis and harness must also be fastened to the transport vehicle to insure user safety.

Again, please refer to the restraint system's instructions.

4.20.1.4 The attendant / transporter must double-check all fastening points for proper connection and tightness to assure the wheelchair user's safety. The attendant / transporter must fully understand the fastening system's usage and its weight limitations.

4.20.1.5 See <https://www.braunability.eu/en/products/tie-downs-and-seatbelts/wtors/> for more information.



CAUTION:

- When transporting or lifting, never hold on to attachments or accessories (front/rear wheels, handrims, casters, footrests, armrests, anti-tippers etc).
- All lifting should be done with a straight back. Straight legs to lift the wheelchair. Carefully carry it up or down steps; be aware of how you place your feet, do not cross them and trip yourself up.

4.20.2 Fitting the Front Restraint

4.20.2.1 Connect the straps around the wheelchair frame and caster bracket as pictured below. The anchor point is marked with a yellow sticker.

4.20.2.2 Take the brakes off and reverse the wheelchair to tension the front straps. Apply wheelchair brakes (the brakes should be left on during transport).

4.20.3 Fitting the Rear Restraint

4.20.3.1 Attach rear straps into rail approximately 300 mm behind the wheelchair backrest.

4.20.3.2 Attached the hooks to the rear frame of the wheelchair as pictured below. Tension the restraint until the wheelchair is secure.



Fitting the Front Restraint



Fitting the Rear Restraint

4.20.4 Fitting Seat Belt

4.20.4.1 Fasten the 3 point safety belt around the user.

4.20.4.2 The occupied wheelchair should be located in a forward-facing configuration, with the parking brake applied.

4.20.4.3 Pelvic restraints should make full contact across the front of the body near the junction of the thigh and pelvis as pictured below (correct seat belt position).

4.20.4.4 Restraints should not be held away from body by wheelchair components such as armrest or wheels as pictured below (Incorrect seat belt position).

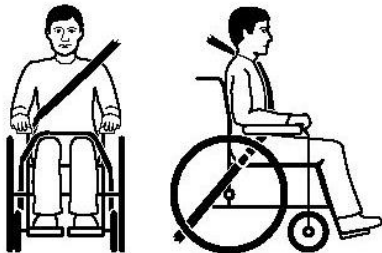

Fitting the Front Restraint



Fitting the Rear Restraint

5. INSPECTION AND MAINTENANCE

5.1 Daily Check

- 5.1.1 Check the following items before travelling. If you find anything abnormal, visit your KARMA wheelchair dealer for further inspection before using it.
- 5.1.2 Examine the brakes and check for any wear, damage and misalignment. Replacing or adjusting the brakes should be carried out by your approved technician.
- 5.1.3 Check that the handgrips are not damaged and are securely bonded to the push handles.
- 5.1.4 Check that the anti-tippers are not damaged and are securely attached.
- 5.1.5 Check that the anti-tippers' wheels and frame are not damaged and are securely mounted.
- 5.1.6 Before using the wheelchair, make sure all nuts and bolts are tight. Check all parts for damage or wear and have a qualified technician replace it if necessary. Check all parts for proper adjustment. Inspect brakes for proper operation.
- 5.1.7 The wheels and tires should be checked periodically for cracks and wear, and should be replaced by a qualified technician.
- 5.1.8 A qualified technician can be found at an authorized distributor/dealer.



CAUTION:

- Visit a KARMA wheelchair dealer for inspection and maintenance if you find anything abnormal.

5.2 Regular Maintenance Record

- 5.2.1 In order to ensure that your wheelchair is in good condition, please contact KARMA authorized dealers regularly and make further wheelchair inspection and maintenance records. We recommend that you inspect and maintain your wheelchair **every six months**.
- 5.2.2 A maintenance/service fee may apply.

**WARNING:**

- Even if you don't use the vehicle for a long time, the wheelchair should still be maintained regularly. You should clean your wheelchair regularly.

Item	Weekly	Monthly
GENERAL		
● Wheelchair rolls straight (no excessive drag or pull to one side)		V
FRAME & CROSS BRACE		
● Inspect frame structure for small cracks/fissures.		V
● Inspect for bent frame or cross bars.		V
BRAKES		
● DON'T interfere with tires when rolling.		V
● Pivot points free of wear and looseness.		V
● Easy to engage.	V	
● Stop the wheelchair from moving when engaged.	V	
SEAT & BACKREST		
● Inspect for rips or sagging.	V	
● Inspect for any loose or broken hardware, such as the frame and etc.		V
CASTERS		
● Inspect the casters for smooth rotation of the caster wheels and caster assembly.		V
● Inspect the caster for any wear in the bearings/mountings and for tire wear or damage.		V
REAR WHEELS		
● Quick-release axles lock properly; lubricate if necessary (applied to quick-release rear wheel only)	V	
● No excessive side movement or binding when lifted and spun.		V
● Inspect for any cracked, bent or broken spokes.	V	

Item	Weekly	Monthly
ARMRESTS		
● Make sure the armrest detaches properly.		✓
FOOTRESTS		
● Inspect the footplate height adjustment bolts are securely tightened.		✓
● Inspect the swing-away footrest release lever for effective locking.		✓
ANTI-TIPPERS		
● Check anti-tippers are not damaged and are securely attached.		✓
TIRES		
● Inspect for flat spots, cracks and wear.	✓	
● If pneumatic tires, check for proper inflation.	✓	
● Check tire tread depth is more than 1 mm.		✓
● If pneumatic tires, check tire pressure. Tire pressures are specified on the side of the tire.	✓	
PELVIC BELTS		
● Check pelvic belts are rigidly fixed and have no sharp edges to let the user's skin be tore and bruised.		✓



CAUTION:

- Never disassemble or modify the wheelchair frame structure. Otherwise, injury or damage may occur. This will void the warranty.
- As with any wheelchair, the wheels and tires should be checked periodically for cracks and wear, and should be replaced. Failure to keep tires at the correct pressure will reduce the braking efficiency.



WARNING:

- Anti-tippers **MUST** be equipped always when user sit on chair.

6. ACCESSORIES

Optional accessories are as below; please contact your dealer for the purchase of these items.



Adjustable Curved Headrest



Elevating and Swing-Away Footrest



Angle Adjustable Footplate



Hemi Armrest



CAUTION:

- Attaching accessories may alter the overall stability and center-of-gravity of the chair. Thus, this should be performed by an authorized dealer/ technician or qualified therapist.

7. TROUBLESHOOTING

Trouble or Problems with Your Wheelchair

You can inspect the following before taking your wheelchair to a KARMA wheelchair dealer.

Problem	Checking Points and Corrective Action
1. Wheelchair Veers Right/Left	<ul style="list-style-type: none">● Check tires for correct and equal pressure.● Check caster bracket angle.● Check that rear wheels are equally spaced from the seat frame.
2. Sluggish Turn or Performance	<ul style="list-style-type: none">● Check tires for correct and equal pressure.● Check for loose nuts and bolts.
3. Caster Flutter/Wobble	<ul style="list-style-type: none">● Check tires for correct and equal pressure.● Check for loose nuts and bolts.● Check caster bracket angle.
4. Squeaks and Rattles	<ul style="list-style-type: none">● Check for loose nuts and bolts.
5. Looseness in Wheelchair	<ul style="list-style-type: none">● Check for loose nuts and bolts.

If you cannot solve the problem by yourself, contact your KARMA wheelchair dealer for help.

8. SPECIFICATIONS

Product Model	VIP2 (VIP2-TR)			
Nominal seat width (mm/in)*	400 / 16	400 / 16	450 / 18	450 / 18
Nominal seat depth (mm/in)**	415 / 16	465 / 18	415 / 16	465 / 18
Front caster / Rear wheel size (in)	6 / 14 · 7 / 14	6 / 14 · 7 / 14	6 / 14 · 7 / 14	6 / 14 · 7 / 14
Backrest height (mm)	510 / 560	510 / 560	510 / 560	510 / 560
Headrest height above seat (mm)	630 ~ 860	630 ~ 860	630 ~ 860	630 ~ 860
Armrest to seat distance (mm)	220 ~ 280	220 ~ 280	220 ~ 280	220 ~ 280
Front location of armrest structure (mm)	385	410	385	410
Seat surface height at front edge (mm)	470 / 490	470 / 490	470 / 490	470 / 490
Footrest to seat distance (mm)	320 ~ 420	320 ~ 420	320 ~ 420	320 ~ 420
Effective seat width (mm)	460	460	510	510
Effective seat depth (mm)	430	470	430	470
Seat plane angle (X°)	1 ~ 36	1 ~ 36	1 ~ 36	1 ~ 36
Backrest angle (X°)	13 ~ 43	13 ~ 43	13 ~ 43	13 ~ 43
Seat to backrest angle (X°)	102 ~ 132	102 ~ 132	102 ~ 132	102 ~ 132
Leg to seat angle (X°)	100	100	100	100
Overall length with legrest (mm)	1070	1120	1070	1120
Overall width (mm)	630	630	680	680
Overall height (mm)	1380	1380	1380	1380
Folded length (mm)	775	825	775	825
Folded width (mm)	355	355	355	355
Folded height (mm)	680	680	680	680
Total mass (kg)	24.4	24.7	24.9	25.2
Mass of the heaviest part (kg)	17.8	18.0	18.1	18.3
Maximum user weight (kg)	115	115	115	115
Minimum turning radius (mm)	905	975	905	975
Minimum turning radius without user (mm)	830	890	830	890
Pivot width (mm)	1210	1280	1210	1280
Static stability downhill (X°)	10	10	10	10
Static stability uphill (X°)	16 (with anti-tippers)	16 (with anti-tippers)	16 (with anti-tippers)	16 (with anti-tippers)
Static stability sideways (X°)	10	10	10	10
Handrim diameter (mm)	N/A	N/A	N/A	N/A
Horizontal location of axle (mm)	90	90	90	90

* **Nominal seat width** is measured the width of seat cushion at 120mm in front of the backrest. This value is mainly used in the product ordering process.

** **Nominal seat depth** is measured from the front end of the seat cushion to the back cushion. This value is mainly used in the product ordering process.

- The actual product specifications differ from the data in the table by ± 1 cm ± 0.5 kg.

- The actual product specifications may vary according to different configurations.

- KARMA reserves the right to modify information herein without further notice.

- Please scan the **QR code** to watch more instructions of the measurement methods on the KARMA website.



Product Model	VIP2 (VIP2-TR)			
Nominal seat width (mm/in)*	400 / 16	400 / 16	450 / 18	450 / 18
Nominal seat depth (mm/in)**	415 / 16	465 / 18	415 / 16	465 / 18
Front caster / Rear wheel size (in)	6 / 20 · 7 / 20	6 / 20 · 7 / 20	6 / 20 · 7 / 20	6 / 20 · 7 / 20
Backrest height (mm)	510 / 560	510 / 560	510 / 560	510 / 560
Headrest height above seat (mm)	630 ~ 860	630 ~ 860	630 ~ 860	630 ~ 860
Armrest to seat distance (mm)	220 ~ 280	220 ~ 280	220 ~ 280	220 ~ 280
Front location of armrest structure (mm)	385	410	385	410
Seat surface height at front edge (mm)	470 / 490	470 / 490	470 / 490	470 / 490
Footrest to seat distance (mm)	320 ~ 420	320 ~ 420	320 ~ 420	320 ~ 420
Effective seat width (mm)	460	460	510	510
Effective seat depth (mm)	430	470	430	470
Seat plane angle (X°)	1 ~ 36	1 ~ 36	1 ~ 36	1 ~ 36
Backrest angle (X°)	13 ~ 43	13 ~ 43	13 ~ 43	13 ~ 43
Seat to backrest angle (X°)	102 ~ 132	102 ~ 132	102 ~ 132	102 ~ 132
Leg to seat angle (X°)	100	100	100	100
Overall length with legrest (mm)	1070	1120	1070	1120
Overall width (mm)	660	660	710	710
Overall height (mm)	1380	1380	1380	1380
Folded length (mm)	840	890	840	890
Folded width (mm)	380	380	380	380
Folded height (mm)	715	715	715	715
Total mass (kg)	25.4	25.6	25.6	25.8
Mass of the heaviest part (kg)	15.4 (20Q) 19.0 (20F)	15.6 (20Q) 19.2 (20F)	15.6 (20Q) 19.2 (20F)	15.8 (20Q) 19.4 (20F)
Maximum user weight (kg)	115	115	115	115
Minimum turning radius (mm)	905	975	905	975
Minimum turning radius without user (mm)	830	890	830	890
Pivot width (mm)	1210	1340	1210	1340
Static stability downhill (X°)	10	10	10	10
Static stability uphill (X°)	16 (with anti-tippers)	16 (with anti-tippers)	16 (with anti-tippers)	16 (with anti-tippers)
Static stability sideways (X°)	10	10	10	10
Handrim diameter (mm)	430	430	430	430
Horizontal location of axle (mm)	90	90	90	90

* **Nominal seat width** is measured the width of seat cushion at 120mm in front of the backrest. This value is mainly used in the product ordering process.

** **Nominal seat depth** is measured from the front end of the seat cushion to the back cushion. This value is mainly used in the product ordering process.

- The actual product specifications differ from the data in the table by ± 1 cm ± 0.5 kg.

- The actual product specifications may vary according to different configurations.

- KARMA reserves the right to modify information herein without further notice.

- Please scan the **QR code** to watch more instructions of the measurement methods on the KARMA website.





CAUTION

- Please don't travel across a slope (in any direction) greater than 7 degrees.
- **DON'T** stand on the footplate directly.

9. CLEANING & RECYCLING

9.1 Cleaning

In order to lengthen the life of your wheelchair, it is suggested that you clean the wheelchair periodically (if not daily), especially after it is used in the rain or snow. We suggest that you don't use your wheelchair in the rain or snow. If you are travelling and get caught in the rain, we suggest you try to find a shelter while waiting it out. If you can't find any shelter, proceed to your destination.

9.1.1 Frame

9.1.1.1 Wipe with a damp cloth. **DO NOT** use any abrasive material to clean it.

9.1.1.2 Although the frame of your wheelchair is aluminum, some parts, such as screws, nuts and spokes of wheels still get rusted if they are exposed to the humid environment. Always keep it dry and clean.

9.1.2 Upholstery

9.1.2.1 When cleaning the upholstery, use warm water and a mild soap.

9.1.2.2 Upholstery cleaner/foam can also be used. Other cleaning solvents are excluded.

9.2 Recycling

A post-consumer recycling plan should follow the Environmental Protection Administration's regulations. The items listed below are for reference only as local laws and regulations may vary.

Material	Part Name	Method
Aluminum-alloy	Frame	Recyclable
Plastic	Modular Components	Recyclable
Paper	Owner's Manual	Recyclable
Steel	Brackets	Recyclable

9.2.1 There are organizations in many countries you can find on the Internet that will accept used goods for charity. Please search the information highway to help less fortunate individuals and protect our planet for future generations. If you do not have access to the world wide web please use your local phone directory, ask for operator assistance or go to your local government center for more information. Earth Day is every day.

9.2.2 Check with your local recycling center on where and how to recycle your wheelchair as this information varies from region to region.

10. WARRANTY

10.1 Serial Number

To ensure after-sale service and warranty, please record and fill in the serial number which can be found on the frame.

This warranty is VOID if the original chair serial number is removed or altered.

Model	
Serial Number	

10.2 Warranty Policy

10.2.1 Contents and Duration of Warranty

10.2.1.1 If the parts of the product need to be repaired or replaced due to manufacturing defects, they can be repaired or replaced free of charge within the warranty period (a repair of this kind will hereafter be called warranty maintenance).

10.2.1.2 Frame and cross-braces are warranted for a period of 5 years and gas strut for a period of 1 year after delivery to the customer, then the affected parts will be repaired or replaced free of charge.

10.2.1.3 Consumable parts such as brakes, bearings, footplates, pads, side guards, upholsteries, wheels and similar parts are excluded from the warranty.

10.2.1.4 Warranty maintenance can be performed by authorized KARMA

- wheelchair dealers only.
- 10.2.1.5 KARMA is not responsible for the transportation costs for repair and replacement.
- 10.2.1.6 Warranty maintenance is the repair or replacement according to the condition of the parts, and replaced parts will be the property of KARMA.
- 10.2.1.7 KARMA reserves the right to modify product specifications without further notice; KARMA is not responsible for any changes to product specifications.
- 10.2.2 The Claims from This Warranty Shall Not Arise for The Following Reasons
- 10.2.2.1 The product or part has been damaged by accident, improper use, incorrect assembly or poor maintenance. The evaluation of it is the privilege of KARMA.
- 10.2.2.2 Damage resulting from normal wear and tear.
- 10.2.2.3 Any overloading of the product, please check the label for maximum user weight.
- 10.2.2.4 The product or part has not been maintained or serviced in accordance with the manufacturer's recommendations as shown in the User Manuals and/or the Service Manuals.
- 10.2.2.5 Use or install parts or accessories which are not manufactured or not approved by KARMA.
- 10.2.2.6 Damage resulting from use in unsuitable environments.
- 10.2.2.7 Damage resulting from any addition, modification, or alteration of the product or parts without the approval by KARMA.
- 10.2.2.8 Damage resulting from external factors, such as chemicals, oil, debris, etc.
- 10.2.2.9 Damage caused by natural disasters.
- 10.2.3 KARMA is Not Responsible for The Following Costs
- 10.2.3.1 Replacement or refill of consumable parts, oil or lubricant.
- 10.2.3.2 Product inspection, adjustment, lubrication, cleaning, etc.
- 10.2.3.3 The costs of regular inspection and maintenance of product.

10.2.3.4 The product is not repaired by the authorized dealer designated by KARMA.

10.2.4 Responsibilities

10.2.4.1 The Responsibilities of the User

10.2.4.1.1 Fully adhere to operation guidelines set forth in this manual.

10.2.4.1.2 Perform self-inspection and basic maintenance.

10.2.4.1.3 Keep a record of self-inspections and basic maintenance.

10.2.4.1.4 Not permit any alteration, addition, or modification or use of parts not manufactured by KARMA.

10.2.4.1.5 Thoroughly read and understand this manual.

10.2.4.2 The Responsibilities of the Dealer

10.2.4.2.1 Follow this manual and educate user about product operation and basic maintenance.

10.2.4.2.2 Verify and check whether the warranty conditions are met.

10.2.4.2.3 Provide relevant warranty information and recommendations for improvements.

10.2.5 Transfer of Warranty Rights

If you purchase a second-hand KARMA wheelchair while it is still within the warranty period, bring this user manual and the wheelchair to the authorized dealer and perform necessary product inspection, maintenance and warranty inheritance procedure.

Full Name:	
Gender:	
Date of Birth:	
Address:	
Model:	
Serial Number:	
Date of Purchase:	

Dealer's Data

Name of the Store:	
Phone Number and Address:	

If you have any suggestions on how to improve our products, please don't hesitate contacting your local dealer to let us know what you think of your wheelchair. Thank you and enjoy.

karma

A Better Wheelchair, A Better Fit



KARMA MOBILITY S.L European Support Center.
www.karmamobility.es
+34 984 390 907
karma@karmamobility.es

KARMA MOBILITY LTD. UK representative
www.karmamobility.co.uk
+44 845 630 3436
info@karmamobility.co.uk

KARMA MEDICAL PRODUCTS CO., LTD.
www.KarmaMedical.com
+886 5 206 6688
globalsales@karmam.com.tw